

KENWOOD

KDC-X615
KDC-6015
KDC-515S

Take the time to read through this instruction manual.

Familiarity with installation and operation procedures will help you obtain the best performance from your new CD-receiver.

For your records

Record the serial number, found on the back of the unit, in the spaces designated on the warranty card, and in the space provided below. Refer to the model and serial numbers whenever you call upon your KENWOOD dealer for information or service on the product.
Model KDC-X615/6015/515S
Serial number _____

CD-RECEIVER

INSTRUCTION MANUAL

AMPLI-TUNER-LECTEUR DE CD

MODE D'EMPLOI

REPRODUCTOR DE DISCOS COMPACTOS RECEPTOR DE FM/AM

MANUAL DE INSTRUCCIONES

KENWOOD CORPORATION



©B64-1625-00 (KW)

Contents

Before use

Warning.....	3
Safety precautions.....	4
Handling Compact discs.....	6

General features

Power.....	7
Volume.....	7
Attenuator.....	7
Switching Modes.....	8
Audio Control Setting.....	8
Mobile Preset.....	11
Loudness.....	11
Non-Fading Output.....	11
Theft Deterrent Faceplate.....	12

Tuner features

Tuning.....	14
Station Preset Memory.....	14
Auto Memory Entry.....	14
Switching Display for Tuner.....	15
Station Name Preset Play (SNPP).....	15
Station Name Preset (SNPS).....	16

CD/External disc control features

Playing CDs.....	18
Playing Other Disc mode.....	18
Switching Display for Discs.....	19
Fast Forwarding and Reversing Disc Play.....	19
Track Search.....	19
Disc Search.....	20
Direct Track Search.....	20
Direct Disc Search.....	20
Track / Disc Repeat.....	20
Track Scan.....	21
Disc Scan.....	21
Random Play.....	21
Magazine Random Play.....	22
Text Scroll.....	22
Disc Name Preset Play (DNPP).....	22
Presetting Disc Names (DNPS).....	24

Menu settings

Menu System.....	26
Touch Sensor Tone.....	26
Manual Time Adjustment.....	26
Calendar Adjustment.....	27
Calendar Mode.....	27
Memo Mode.....	28
Security Code.....	28
Selectable Illumination.....	29
Contrast Adjustment.....	30
Dimmer.....	30
Switching Graphic Display.....	30
Black Mask.....	30
Switching preout.....	30
KEX/ec4/dB (Sound Coordinate system).....	30
External Amp Control.....	31
Clean Reception System Circuit (CRSC).....	31
Text Scroll.....	31

Basic Operations of remote.....32

Installation

Accessories.....	35
Installation Procedure.....	35
Connecting Wires to Terminals.....	36
Installation.....	37

Troubleshooting Guide.....40

Specifications.....43

▲ Warning

▲ CAUTION

Use of controls or adjustments or performance of procedures other than those specified herein may result in hazardous radiation exposure.

In compliance with Federal Regulations, following are reproductions of labels on, or inside the product relating to laser product safety.

KENWOOD CORPORATION
2967-3, ISHIKAWA-CHO,
HACHIOJI-SHI
TOKYO, JAPAN

KENWOOD CORP. CERTIFIES THIS EQUIPMENT
CONFORMS TO DHHS REGULATIONS NO 21 CFR
1040. 10, CHAPTER 1, SUBCHAPTER J.

Location : Bottom Panel

FCC WARNING

This equipment may generate or use radio frequency energy. Changes or modifications to this equipment may cause harmful interference unless the modifications are expressly approved in the instruction manual. The user could lose the authority to operate this equipment if an unauthorized change or modification is made.

NOTE

This equipment has been tested and found to comply with the limits for a Class B digital device, pursuant to Part 15 of the FCC Rules. These limits are designed to provide reasonable protection against harmful interference in a residential installation. This equipment may cause harmful interference to radio communications, if it is not installed and used in accordance with the instructions. However, there is no guarantee that interference will not occur in a particular installation. If this equipment does cause harmful interference to radio or television reception, which can be determined by turning the equipment off and on, the user is encouraged to try to correct the interference by one or more of the following measures:

- Reorient or relocate the receiving antenna.
- Increase the separation between the equipment and receiver.
- Connect the equipment into an outlet on a circuit different from that to which the receiver is connected.
- Consult the dealer or an experienced radio/TV technician for help.

NOTE

This Class B digital apparatus complies with Canadian ICES-003.

Safety precautions

▲WARNING

To prevent injury or fire, take the following precautions:

- Insert the unit all the way in until it is fully locked in place. Otherwise it may fall out of place when jolted.
- When extending the ignition, battery, or ground wires, make sure to use automotive-grade wires or other wires with a 0.75mm² (AWG18) or more to prevent wire deterioration and damage to the wire coating.
- To prevent a short circuit, never put or leave any metallic objects (such as coins or metal tools) inside the unit.
- If the unit starts to emit smoke or strange smells, turn off the power immediately and consult your Kenwood dealer.
- Make sure not to get your fingers caught between the faceplate and the unit.
- Be careful not to drop the unit or subject it to strong shock.
The unit may break or crack because it contains glass parts.
- Do not touch the liquid crystal fluid if the LCD is damaged or broken due to shock. The liquid crystal fluid may be dangerous to your health or even fatal.
If the liquid crystal fluid from the LCD contacts your body or clothing, wash it off with soap immediately.

▲CAUTION

To prevent damage to the machine, take the following precautions:

- Make sure to ground the unit to a negative 12V DC power supply.
- Do not open the top or bottom covers of the unit.
- Do not install the unit in a spot exposed to direct sunlight or excessive heat or humidity. Also avoid places with too much dust or the possibility of water splashing.
- Do not subject the faceplate to excessive shock, as it is a piece of precision equipment.
- When replacing a fuse, only use a new one with the prescribed rating. Using a fuse with the wrong rating may cause your unit to malfunction.
- To prevent a short circuit when replacing a fuse, first disconnect the wiring harness.
- Do not place any object between the faceplate and the unit.
- Do not use your own screws. Use only the screws provided. If you use the wrong screws, you could damage the unit.
- Do not apply excessive force to the moving faceplate. Doing so will cause damage or malfunction.
- Do not apply excessive force to the open faceplate or place objects on it. Doing so will cause damage or breakdown.

IMPORTANT INFORMATION

You cannot connect the unit directly to the following CD automatic changers. If you want to use older changers with the unit, follow the directions below according to the type of changer you own:

• KDC-C200 / KDC-C300 / KDC-C400

Use the extension cable and the control box attached to the CD changer, and the optional CA-DS100 converter cord.

• KDC-C301 / KDC-C600 / KDC-C800 / KDC-C601 / KDC-C401

Use the extension cable attached to the CD changer, and the optional CA-DS100 converter cord.

• KDC-C100 / KDC-C302 / C205 / C705 / non-Kenwood CD changers

Cannot be used with this model.

▲CAUTION

You can damage both your unit and the CD changer if you connect them incorrectly.

▲CAUTION

Do Not Load 3-in. CDs in the CD slot

If you try to load a 3 in. CD with its adapter into the unit, the adapter might separate from the CD and damage the unit.

NOTE

- If you experience problems during installation, consult your Kenwood dealer.
- Press the reset button if the disc auto changer is first controlled and operates incorrectly. The original operating condition will return.



Reset button

- We recommend the use of the Security Code function (see p. 28) to prevent theft.
- Characters in the LCD may become difficult to read in temperatures below 41 °F (5 °C).

- The illustrations of the display and the panel appearing in this manual are examples used to explain more clearly how the controls are used. Therefore, what appears on the display in the illustrations may differ from what appears on the display on the actual equipment, and some of the illustrations on the display may represent something impossible in actual operation.
- The functions that can be used and the information that can be displayed will differ depending on the external disc players being connected.

Cleaning the Faceplate Terminals

If the terminals on the unit or faceplate get dirty, wipe them with a dry, soft cloth.

Cleaning the Unit

If the front panel gets dirty, turn off the power and wipe the panel with a dry silicon cloth or soft cloth.

▲CAUTION

Do not wipe the panel with a hard cloth or a cloth dampened by volatile solvents such as paint thinner and alcohol. They can scratch the surface of the panel and/or cause the indicator letters to peel off.

Cleaning the CD Slot

As dust tends to accumulate in the CD slot, clean it every once in a while. Your CDs can get scratched if you put them in a dusty CD slot.

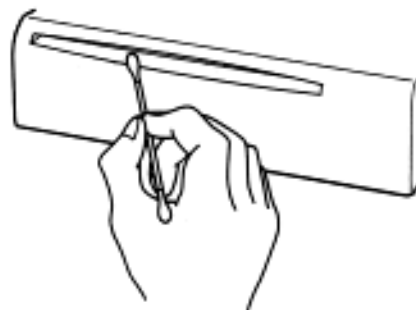

Lens Fogging

Right after you turn on the car heater in cold weather, dew or condensation may form on the lens in the CD player of the unit. Called lens fogging, CDs may be impossible to play. In such a situation, remove the disc and wait for the condensation to evaporate. If the unit still does not operate normally after a while, consult your Kenwood dealer.

Handling Compact discs

Playing a CD that is dirty, scratched or warped can cause the sound to skip and the unit to operate incorrectly, resulting in worsened sound quality. Take the following precautions to prevent your CDs from getting scratched or damaged.

Handling CDs

- Do not touch the recorded side of the CD (the side opposite the label) when holding it.



- Do not stick tape on either side of the CD.

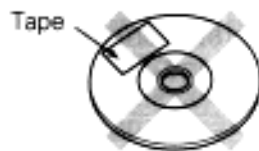

Storing CDs

- Do not store CDs in areas exposed to direct sunlight (such as a car seat or the dashboard) or other hot places.
- Remove CDs from the unit when not listening to them for a while, and put them back in their cases. Do not pile up CDs that are removed from their cases or prop them against something.

Cleaning CDs

If a CD has gotten dirty, wipe it off gently using a commercially available cleaning cloth or a soft cotton cloth, starting from the center of the disc and moving outward. Do not clean CDs with conventional record cleaners, anti-static formulas, or chemicals such as paint thinner or benzene.

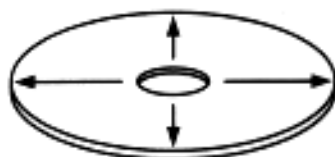

Checking New CDs for Burrs

When playing a new CD for the first time, check that there are not any burrs stuck to the perimeter of the disc or in the central hole. CDs with burrs stuck on them may not load properly or may skip while playing. Remove burrs using a ballpoint pen or a similar utensil.

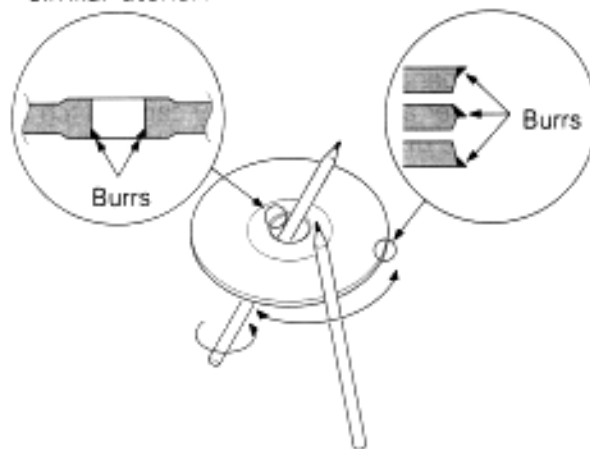

Do Not Load CD Accessories

Do not use commercially available CD accessories that can be loaded into the CD slot, such as stabilizers, protective sheets, or CD cleaning discs, since they can cause the unit to malfunction.

Removing the CD

Only remove the CD from the machine in a horizontal direction, holding it flat. You may damage the surface of the CD if you try pulling it down as it ejects.

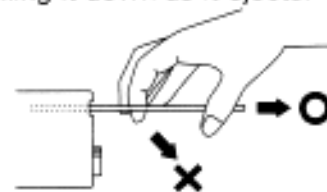

Do Not Use Special Shape CDs

- Be sure to use round shape CDs only for this unit and do not use any special shape CDs. Use of special shape CDs may cause the unit to malfunction.



- Be sure to use CDs with disc mark  only for this unit.

Do Not Use CDs with Sticker on the Labeled Side

Do not use the CD with the label sticker stuck on it. Using such a CD may cause the CD to be deformed and the sticker to peel off, resulting in malfunction of the unit.

General features

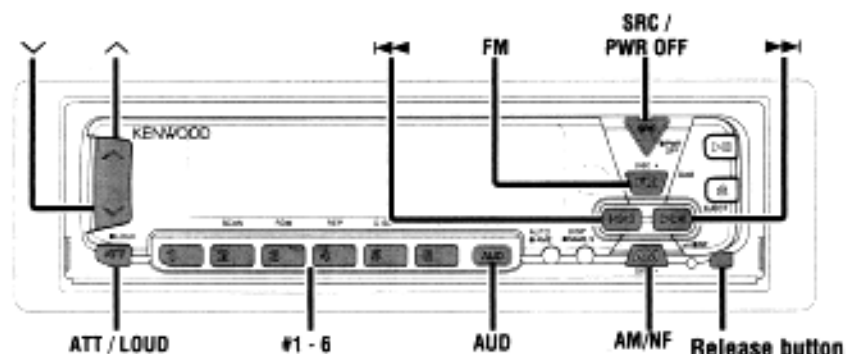

KDC-X615/KDC-6015

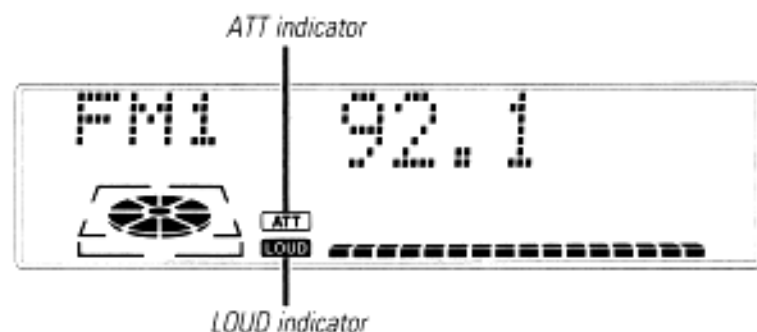

KDC-515S

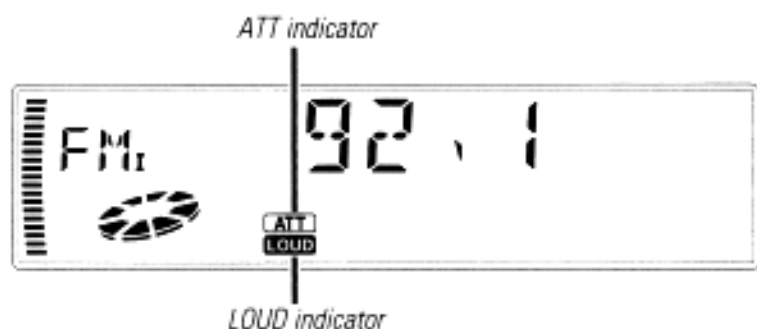

Power

Turning on the power:

Press the SRC (source) button.

NOTE

Turn the power on before carrying out the following procedures.

Turning off the power:

Press the PWR OFF button for at least one second.

Volume

Increasing Volume:

Press the ^ button to turn up the volume.

Decreasing Volume:

Press the v button to turn down the volume.

Attenuator

This function allows you to turn down the volume quickly.

Turning Attenuator On/Off:

Press the ATT button to switch the attenuator on and off.

When the attenuator is on, the ATT indicator blinks.

When the attenuator is off, the volume returns to the original level.

NOTE

Turning the volume up, or turning it all the way down deactivates the attenuator function.

General features

Switching Modes

Switching Modes:

Each time you press the SRC (source) button, the mode switches as follows:

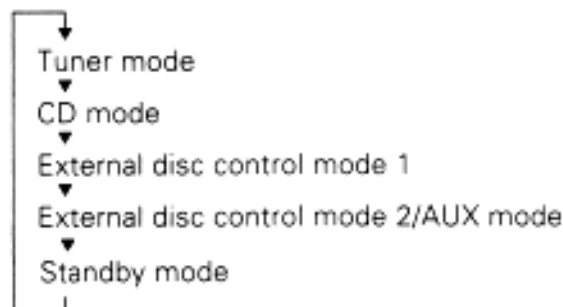

Selecting standby mode:

Press the SRC button repeatedly and switch to "ALL OFF". When "ALL OFF" is displayed, the standby mode is activated. The standby mode turns all functions off while leaving the power to the unit on. Use this mode when you want to have the display illuminated but don't want to listen to anything.

NOTE

- The mode switches to the next mode from any mode which cannot be used.
- The external disc control mode will differ depending on the unit that is connected.
- The AUX mode is available only when the changer / AUX switching adapter (KCA-S210A or CA-C1AX) or CD changer (KDC-CPS85, KDC-CX85, KDC-CPS82 or KDC-CX82) is connected to this unit. During the AUX mode, "AUX" / AUX-name will show in the display. When the CA-C1AX is being used, the AUX Mode will replace the External Disc Control Mode.

NOTE

Presetting AUX-name (Only when the KCA-S210A is connected)

In the AUX mode, press the NAME.S button for at least two seconds. "NAME SET" is display and AUX-name mode is entered. Input the characters, referring to the section on "Presetting Disc Names (DNPS)" (page24).

Audio Control Setting

Adjust various parameters of sound quality.

- 1 Press the AUD button to enter the control mode.
- 2 **Selecting mode**
Press either the FM or AM button.
Each time the button is pressed, the adjustment mode will change.
Please refer to the following for the contents of the adjustment modes.

NOTE Source tone memory

Each source (tape, CD, MD, FM, AM and disc changer) has its own memory in which to store the bass, treble and N-F level settings.

The settings made for a particular source are recalled automatically whenever you use that source (for example, FM mode uses the tone settings made for FM, AM for AM, etc.).

- 3 **Adjust each mode**
Press the ◀▶ button.
Please refer to the following for the adjusting values.
- 4 Press the AUD button to end the control mode.

"Kex"/"ec4"/"EC4" : Recalling the kenwood preset sound setting

Press the preset buttons (#1-6).

Settings: #1;Flat, #2;Rock, #3;Pops/Top40, #4;Jazz, #5;Easy, #6;Scan of #1-5 (KDC-X615/6015 only)

NOTE

- This mode is available only when the Sound coordinate system is on. (page30)
- You can call the following settings with this function; bass center frequency, bass level, bass quality factor, bass extension, treble center frequency, and treble level setting. Their setting values are different depending on the setting of the mobile preset plan mode.

Function of the KDC-X615

"Bass F" : Adjust the center frequency of the bass.

Setting values: 60 / 70 / 80 / 100 (Only when the bass quality factor is set to 1.00, 1.25 or 1.50) / 150 (Only when the bass quality factor is set to 2.00) Hz

NOTE

This mode is available only when the Sound coordinate system is on. (page30)

"Bass"/"BAS" : Adjust the bass level.

Setting values: - 8 - + 8

Function of the KDC-X615

"Bass Q" : Adjust the Bass quality factor.

Setting values: 1.00 / 1.25 / 1.50 / 2.00

NOTE

This mode is available only when the Sound coordinate system is on. (page30)

Function of the KDC-X615

"Bass EXT" : Switch the Bass Extend mode on/off.

Setting values: ON / OFF

(When the bass extend mode is set to on, low frequency response is extended by 20%.)

NOTE

This mode is available only when the Sound coordinate system is on. (page30)

Function of the KDC-X615

"TreF" : Adjust the center frequency of the treble.

Setting values: 10.0 / 12.5 / 15.0 / 17.5 kHz

NOTE

This mode is available only when the Sound coordinate system is on. (page30).

"Treble"/"TRE" : Adjust the treble level.

Setting values: - 8 - + 8

"Balance"/"BAL" : Adjust the balance level.

Setting values: Left 15 - Right 15

"Fader"/"FAD" : Adjust the fader level.

Setting values: Front 15 - Rear 15

Function of the KDC-X615

"NF Level" : Adjust the Non-fading output level.

Setting values: - 15 - + 15

NOTE

- This mode is available only when the non-fading output function is set to on.
- Not available during the Dual zone system is on.

General features

Function of the KDC-X615

"HPF F" : Adjust the frequency of the High-pass filter for front output.

Setting values: Through / 40Hz / 60Hz / 80Hz / 100Hz / 120Hz / 150Hz / 180Hz / 220Hz

NOTE

You can separately set the high-pass filter for front and rear output, including preouts. The high-pass filter works except during non-fading preout when switching to non-fading. The factory default settings for front output and rear output are "through".

Function of the KDC-X615

"HPF R" : Adjust the frequency of the High-pass filter for rear output.

Setting values: Through / 40Hz / 60Hz / 80Hz / 100Hz / 120Hz / 150Hz / 180Hz / 220Hz

NOTE

You can separately set the high-pass filter for front and rear output, including preouts. The high-pass filter works except during non-fading preout when switching to non-fading. The factory default settings for front output and rear output are "through".

Function of the KDC-X615

"LPF NF" : Adjust the frequency of the Low-pass filter for Non-Fading output.

Setting values: 50 Hz / 80 Hz / 120 Hz / Through

NOTE

This mode is available only when the non-fading output function is set to on.

Function of the KDC-X615

"NF Phase" : Adjust the phase for Non-Fading output.

Setting values: Normal (0°) / Reverse (180°)

NOTE

This mode is available only when the non-fading output function is set to on.

"V OFFSET/VOS" : Set the sound level of the each source selected by adjusting the level difference between the basic sound level and the required level.

Setting values: - 8 - ± 0

Function of the KDC-X615

Storing your sound settings:

Press a preset button (#1-6) for at least two seconds except during the bass center frequency, bass level, bass quality factor, bass extension, treble center frequency, and treble level adjust mode.

NOTE

- This setting can be made only when the Sound coordinate system is on. (page30)
- The settings you can preset are, bass center frequency, bass level, bass quality factor, bass extension, treble center frequency, and treble level.

Function of the KDC-X615

Recalling your sound settings:

Press a preset button (#1-6) except during the bass center frequency, bass level, bass quality factor, bass extension, treble center frequency, and treble level adjust mode.

NOTE

This mode is available only when Sound coordinate system is on.

Function of the KDC-6015

Mobile Preset

This function allows you to adjust the setting that is recalled with the sound coordinate system, according to types of speakers.

- 1 Press the SRC button repeatedly to select the standby mode. 'ALL OFF' is displayed when the standby mode is selected.
- 2 Press the AUD button to enter the mobile preset plan mode.
- 3 Press either the ◀◀ or ▶▶ button to select the type of speaker. The setting switches as follows.
Off / For the OEM speaker / For 6/6x9 in. speaker /
For 5/4 in. speaker
- 4 Press the AUD button to end the mobile preset plan mode.

NOTE

- When you change the setting of type of speaker, the bass and treble tone settings are returned to original levels.
- This mode is available only when the Sound coordinate system is on. (page30)

Loudness

This function amplifies low and high tones when the volume is turned down.
The LOUD indicator lights up when the loudness function is on.

Turning Loudness On/Off:

Press the LOUD button for at least one second to switch the loudness on and off.

Function of the KDC-X615

Non-Fading Output

You can turn the non-fading output on and off while the preout is switched to the non-fading preout.

Turning non-fading output On/Off :

Press the NF button for at least one second to set the function ON or OFF.
'NF ON' is displayed when the non-fading output is set ON.

General features

Theft Deterrent Faceplate

The faceplate can be reversed to hide the control panel or detached from the unit, helping to deter theft.

Removing the Faceplate:

- When the control panel is visible
Press the release button.
 - When the control panel has been hidden:
Press the upper side of the faceplate.
- Holding the center part of the faceplate, pull it out.

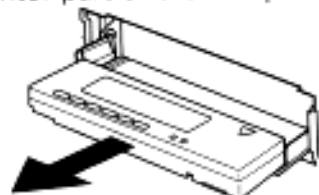

- Push back the bottom of the faceplate bracket until it locks.

CAUTION

- Do not apply excessive force to the faceplate bracket without attaching the faceplate. Doing so will cause the faceplate bracket to be deformed.
- Do not touch the connector on the faceplate bracket after removing the faceplate. Touching the connector may cause damage to the unit.
- Do not touch two metal parts on both sides of the faceplate bracket. Touching those parts may injure you.

NOTE

- The faceplate is a precision piece of equipment and can be damaged by shocks or jolts. For that reason, keep the faceplate in its special storage case while detached.
- Do not expose the faceplate or its storage case to direct sunlight or excessive heat or humidity. Also avoid places with too much dust or the possibility of water splashing.

Reattaching the Faceplate:

- Hold the faceplate so that the control panel faces the front toward you and set the left side of the faceplate in the faceplate bracket.

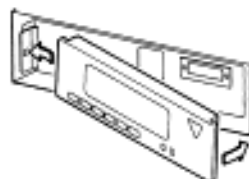

CAUTION

Do not set the right side of the faceplate in the faceplate bracket first, when reattaching the faceplate. Doing so may cause the connector on the faceplate bracket to malfunction.

- Press the right side of the faceplate until it locks.

Hiding the control panel:

- Press the release button and slide open the faceplate.
- Push upward the back of the control panel and reverse the panel.

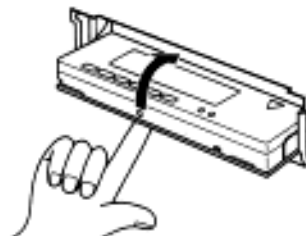

NOTE

The panel cannot be reversed when the faceplate is not attached.

Opening the control panel:

- Press the upper side of the faceplate.
The faceplate will open.
- Push the bottom of the control panel and close the faceplate.

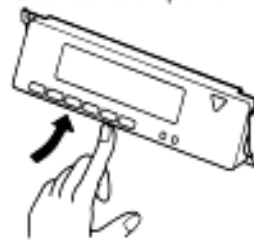

NOTE

The buttons do not work when the control panel is slid.

Tuner features

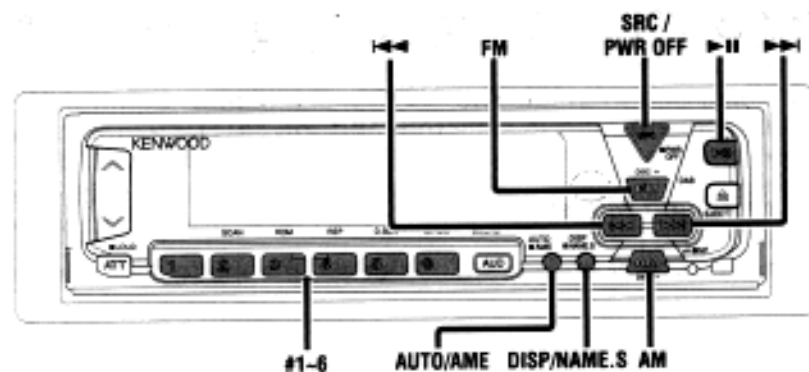

KDC-X615/KDC-6015

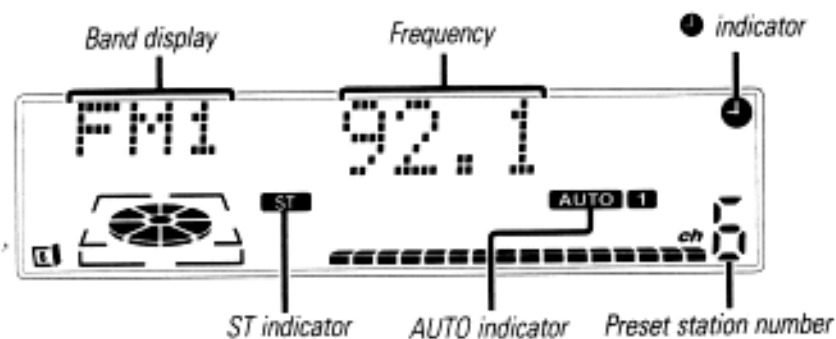

KDC-515S

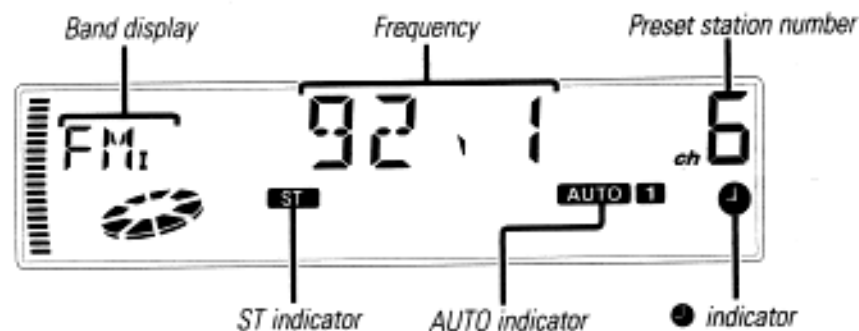

Tuner features

Tuning

You can choose from three tuning modes: auto seek, preset station seek, and manual. The "AUTO 1" indicator lights up when auto seek tuning is selected, and the "AUTO 2" indicator lights when preset station seek tuning is selected.

Selecting Tuning Mode:

Press the AUTO button.

Each time you press the AUTO button, the mode switches as follows.

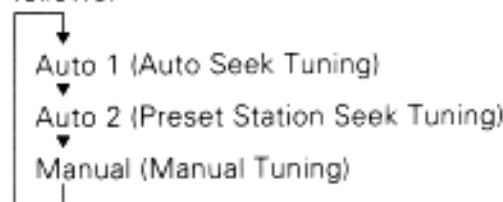

Tuning:

- 1 Press the SRC (source) button repeatedly to select the tuner mode. "TUNER" is displayed when the tuner mode has been selected.
- 2 Press either the FM or AM button to select the band. Each time you press the FM button, the band switches between the FM1, FM2 and FM3 (which are used for groups of preset stations). Press the AM button to select the AM band.
- 3
 - Auto Seek Tuning
Press the ►► button to seek higher frequencies.
Press the ◄◄ button to seek lower frequencies.
 - Preset station seek tuning
Press the ►► button to move to the next preset station (i.e., the one with the next highest number), and the ◄◄ button to move to the last preset station (i.e., the one with the next lowest number).
 - Manual Tuning
Press the ►► button to increase the frequency by one step.
Press the ◄◄ button to decrease the frequency by one step.

NOTE

The ST indicator lights up when stereo broadcasts are being

received.

Station Preset Memory

Store the frequency of a station. You can then recall that station with a single touch of a button.

- 1 Select the band/ station that you want to have stored.
- 2 Press the button (#1-6) that you want to use for the station, for at least two seconds.
The button number blinks once in the display to indicate that the data has been stored.

Recalling a Preset Station:

Press the preset station button (#1-6) for the desired station. The number of the recalled station is displayed.

NOTE

You can store six stations in each of the FM1, FM2, FM3, and AM bands.

Auto Memory Entry

You can automatically store all the receivable frequencies in the band currently being listened to, and then recall them with the touch of a button later. This function is especially useful when you are travelling and do not know what stations are available. Up to six frequencies can be stored this way.

- 1 Select the band for auto memory entry.
- 2 Press the AME button for at least two seconds to start auto memory entry.
The numbers of the preset station buttons are shown in order. When all the stations in a certain band are stored in the preset memory, the auto memory entry stops. The tuner then plays the last station received.

Recalling a Preset Station:

Press the preset station button (#1-6) for the desired station. The number of the recalled station is displayed.

Switching Display for Tuner

You can change the display used when listening to the radio.

Changing the Display:

Each time you press the DISP button, the display changes as follows:

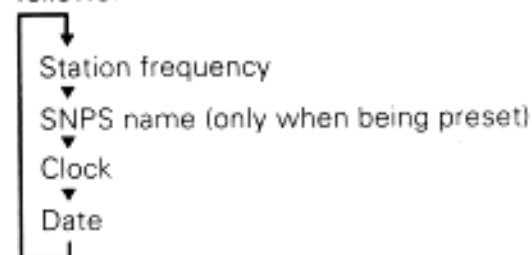

NOTE

The ● indicator lights while the clock is displayed.

Function of the KDC-X615/KDC-6015

Station Name Preset Play (SNPP)

(Function of Remote)

You can search for the station for any station if its name has been preset using Station Name Preset.

- 1 Press the DNPP button on the remote. "SNPP" will be displayed once the station name preset play mode is entered. The names of the stations stored in the band currently listened to are displayed in the following order for five seconds each:

→ FM1 ↔ FM2 ↔ FM3 ↔ AM ←

Each time you press the ►► button, the station display switches in the forward direction.

Each time you press the ◀◀ button, the station display switches in the reverse direction.

Stations whose names have not been stored will be displayed as frequencies.

NOTE Changing the Displayed Band

Pressing the FM button switches between the FM1, FM2, FM3 and AM displays, in that order.

Pressing the AM button switches between the displays in the reverse direction.

- 2 **Once the name is displayed for the station you want to listen to**

Press the OK button.

Reception starts of the displayed station, and the station name preset play mode ends.

Canceling mode during input:

Press the DNPP button.

The station name preset play mode is canceled.

Tuner features

Station Name Preset (SNPS)

You can assign names to radio stations with the Station Preset Memory. Up to 32 FM stations and 16 AM stations can be assigned names.

- Adjust the frequency to the station whose name you want to enter.

NOTE

The station name preset function cannot be used when a program service name or radio text is displayed.

- Press the NAME.S button for at least two seconds. "NAME SET" is displayed once the station name preset mode is entered. The cursor will blink in the position where letters are entered.
- Press either the ◀◀ or ▶▶ button to move the cursor to the desired position. The ◀◀ button moves the cursor to the left, and the ▶▶ button to the right. You can also move the cursor left or right by pressing the ◀◀ or ▶▶ buttons, respectively, on the remote.
- Each time the ▶▶ button is pressed, the characters to be entered change as listed below. Press the FM or AM button to display the desired character. Characters that can be displayed are as follows.

Alphabet (upper case): A ~ Z

Alphabet (lower case): a ~ z (KDC-X615/6015 Only)

Numerals and symbols: 0~9 @ " ' ` % & * + - = , . / \ < > []

Special characters: á à é è í î ó ò ú û ñ ç \$ ß ¡ ¨
 ä å æ ë ì ï ô õ ü ù ã ç š ž ÿ ¡ ¨
 (KDC-X615/6015 Only)

NOTE Direct Alphabet Input

Direct input can be made of letters (alphabetical) with the letter entry buttons on the remote.

Example: Use the following table to enter the name "DANCE".

Character	Button to press	# Times pressed
"D"	#3	1
"A"	#2	1
"N"	#6	2
"C"	#2	3
"E"	#3	2

- Continue steps 3 and 4 until all the characters are chosen for the name.

NOTE

You can enter up to 8 characters for each name.

6 Assigning Names

- Press the NAME.S button on the unit or the OK button on the remote. The name of the station is stored in memory, and the Station Name Preset mode ends. Also, if you make no input for 10 seconds, the name will be stored up to the point that you have entered, and the mode ends.

NOTE

- You can assign names to up to 32 FM stations and 16 AM stations.
- All the station names will be erased if you press the RESET button.
- If you want to change the name of a station, first display the name of the station (following steps 1 and 2 above), then change the letter(s) that you want by following steps 3 and 4.

CD/External disc control features

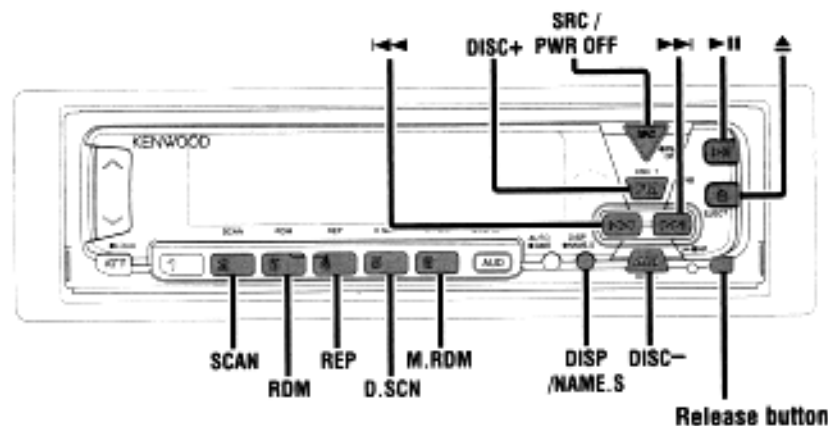

KDC-X615/KDC-6015

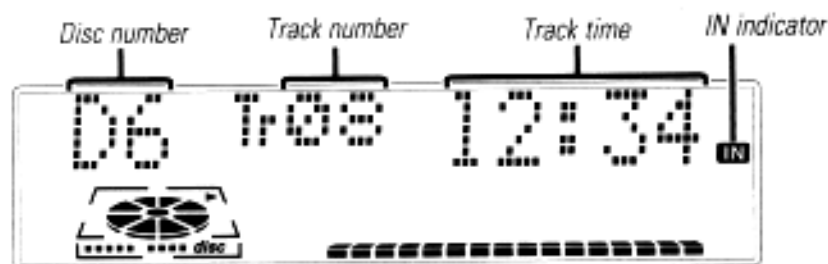

KDC-515S

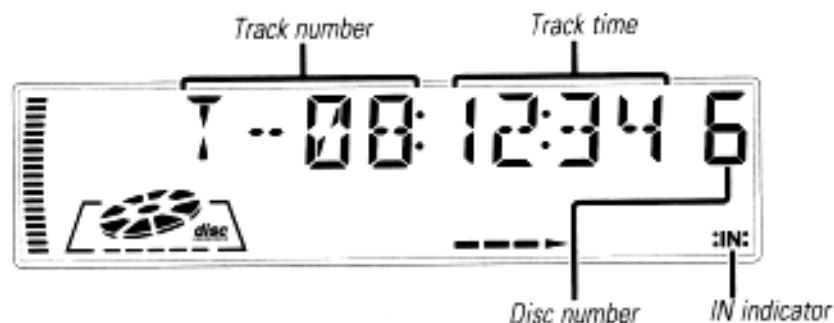

- When a unit equipped with an O-N switch is to be connected, please also see the instruction manual of this unit.

Set the O-N switch to "N". "N"-operation will be set.

"N"-operation:

- The disc title and track title of the CD text can be displayed.
- The disc name will be displayed when the name has been registered to any connected unit with the Presetting Disc Names function, or when the playing unit contains a disc to which the disc title has been recorded.

"O"-operation:

- CD text cannot be displayed.
- Regardless of the control unit, the characters that can be registered with the Presetting Disc Names function are "A-Z 0-9 /, +, -, *, =, <, >, [,]".
- The disc name will be displayed when the name has been registered to the playing unit with the Presetting Disc Names function.

NOTE

The CD text, Presetting Disc Names, and Disc Name Preset Play functions may not be operational depending on the unit.

CD/External disc control features

Playing CDs

Playing CDs:

Press the release button to slide open the faceplate, showing the CD insertion slot.

Holding the CD with the labeled side facing up, insert it in the slot. The CD will start playing. Push back the bottom of the faceplate with your hand until it locks.

The "IN" indicator will light when a CD has been inserted.

▲CAUTION

When inserting a CD, make sure the CD has been completely drawn in before pushing back the faceplate. Failing to do so might scratch the CD.

Playing CDs Already Inserted:

Press the SRC (source) button repeatedly to select the CD mode.

"CD" is displayed when the CD mode has been selected.

The CD will start playing.

Pausing and Restarting CD Play:

Press the ►|| button to make the disc pause.

Press the same button again to start play again.

Eject:

Press the release button and slide open the faceplate.

Press the ▲ button.

The CD stops playing and ejects from the slot.

Push back the bottom of the faceplate with your hand until it locks.

▲CAUTION

- Do not attempt to insert a CD into the slot if another one is already there.
- The unit can only play 5 in. CDs. If you insert a 3 in. CD, it will get stuck inside and can cause the unit to malfunction.
- When the faceplate has been slid open, it might interfere with the shift lever or something else. If this happens, pay attention to safety and move the shift lever or take an appropriate action, then operate the unit.
- Do not use the unit with the faceplate in the open condition. Doing so will cause breakdown.

NOTE

- When you load a CD and eject it right away, the next time you try to insert the CD may not load. In such a situation, take the CD out for a moment and then reinsert it.
- The only buttons that will work during the eject state are the ▲ and ATT buttons.

Playing Other Disc mode

This function permits the connection of optional players and the playing of discs other than the loaded CD (in the current unit).

Playing Discs:

Press the SRC button repeatedly to select the external disc control mode.

The disc will start playing.

NOTE

The external disc control mode will differ, depending on the unit that is connected.

Mode Display Examples

- "CD2" ...when a CD player is connected
- "DISC" ...when a disc changer is connected
- "DISC-1" , "DISC-2" ...when two disc changers are connected

Pausing and Restarting Disc Play:

Press the ►|| button to make the disc pause.

Press the same button again to start play again.

NOTE

- When one disc has finished playing its last track, the next disc in the changer will start playing. When the last disc in the changer has finished, the player will return to the first disc and start playing it.
- Disc #10 is displayed as "0".

Switching Display for Discs

Switch the display that appears while discs are playing.

Switching Display for Discs:

Each time you press the DISP button, the display during disc play switches as follows:

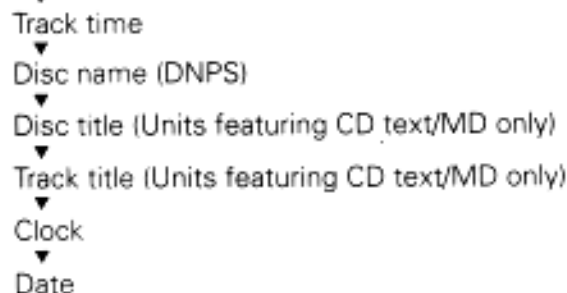

NOTE

- You can give names to discs through the presetting disc name function (see p. 24).
Note that depending on the unit, display may not be possible.
- If you try to display the name of a disc that doesn't have one, "NO NAME" is displayed instead.
- When there is an attempt to display the title of a disc for which the disc title/track title has not been recorded, "NO TEXT" is displayed for CD and "NO TITLE/NO NAME" is display for MD.
- Depending on the type of characters of the CD Text, some characters may not be displayable.
- The  indicator lights while the clock is displayed.

Fast Forwarding and Reversing Disc Play

Fast Forwarding Disc Play:

Hold down on the  button.
Release your finger to play the disc at that point.

Reversing Disc Play:

Hold down on the  button.
Release your finger to play the disc at the point.

NOTE

You cannot use reverse play between tracks depending on the model being connected. Instead, the reverse play function is canceled when it reaches the beginning of a track, at which point normal play will automatically resume.

Track Search

Search forward or backward through the tracks on the disc until you reach the one that you want to listen to.

Making a Reverse Track Search:

Press the  button to display the desired track number.
Press once to search back to the beginning of the current track, twice to search back to the beginning of the previous track, and so forth.
Play starts at the beginning of the displayed track number.

NOTE

Pressing the  button while listening to track 1 will only search back to the beginning of that track. The reverse search is not "recycled" to the last track on the disc.

Making a Forward Track Search:

Press the  button to display the desired track number.
Press once to fast forward to the next track, twice to fast forward to the track after that, and so forth.
Play starts at the beginning of the displayed track number.

NOTE

You cannot make a forward track search when listening to the last track on a disc.

CD/External disc control features

Disc Search

(Function of disc changers)

Search forward or backward through the discs in a disc changer.

Making a Reverse Disc Search:

Press the DISC- button to display the desired disc number. Each time the button is pressed, the displayed disc number decreases by one. Play starts at the beginning of the displayed disc.

Making a Forward Disc Search:

Press the DISC+ button to display the desired disc number. Each time the button is pressed, the displayed disc number increases by one. Play starts at the beginning of the displayed disc.

NOTE

"LOAD" is displayed when discs are being exchanged on the disc changer.

Function of the KDC-X615

Direct Track Search

(Function of Remote)

Using the remote, directly input the track number that you want to listen to.

- Using the number buttons on the remote, input the number of the track that you want to listen to. The selected track number will blink in the display for 10 seconds. If you make no further input in the 10-second period, the number entry mode will automatically be canceled.
- Press either the ◀◀ or ▶▶ button while the track number is blinking. The track starts playing.

Canceling Direct Track Search While It Is Operating:

Press the ▶|| button.

NOTE

You cannot use the direct track search function while doing track

or disc scans or using random or magazine-random play.

Function of the KDC-X615

Direct Disc Search *(Function of disc changers with remote)*

Using the remote, directly input the disc number that you want to listen to.

- Using the number buttons on the remote, input the number of the disc that you want to listen to. The selected disc number will blink in the display for 10 seconds. If you make no further input in the 10-second period, the number entry mode will automatically be canceled.

NOTE

- Input "0" to select disc 10.
 - If you input more than two numbers all at once, a search will be made only of the last number input.
- Press either the DISC+ or DISC- button while the number inputted is blinking. The disc starts playing.

Canceling Direct Disc Search While It Is Operating:

Press the ▶|| button.

Track / Disc Repeat

Repeat playing the track or the disc currently being listened to.

Turning Repeat Play On/Off:

Press the REP button to switch repeat track/disc play on and off as follows:

Track Repeat ON

Disc Repeat ON (Function of disc changers)

Track/Disc Repeat OFF

"T-Repeat/T-REP ON" is displayed and the track number blinks in the display when track repeat is on.

"D-Repeat/D-REP ON" is displayed and the disc number blinks in the display when disc repeat is on.

NOTE

Repeat play is canceled when you eject the disc.

Track Scan

Successively play the beginning of each track on a disc until you find the track that you want to listen to.

Starting the Track Scan :

Press the SCAN button. "T-Scan/TSCN ON" is displayed and the first 10 seconds of each track will be played, in order. The track number currently being heard blinks in the display.

Stopping to Listen to the Track Being Scanned:

Press the ►|| or SCAN button again to stop the scan and keep on listening to a track normally.

NOTE

- The track scan function is canceled when you eject the disc.
- The track scan function only scans each track on a disc once.

Disc Scan

(Function of disc changers)

Successively play the beginning of each disc on a changer until you find the one that you want to listen to.

Starting the disc scan:

Press the D.SCN button. "D-Scan/DSCN ON" is displayed and the first 10 seconds of each disc will be played, in the order they are loaded on the changer.

The disc number currently being heard blinks in the display.

Stopping to Listen to the Disc Being Scanned:

Press the ►|| or D.SCN button again to stop the scan and keep on listening to the disc normally.

NOTE

- The disc scan function is canceled when you eject the disc.
- The disc scan function only scans each disc on the changer once.
- "LOAD" is displayed when discs are being exchanged on the disc changer.

Random Play

Play all the tracks on the current disc in random order.

- 1 Press the RDM button to switch random play on and off. "Random/RDM ON" is displayed when random play is turned on. The track number will change over and over in the display as the next track is being selected. When the track has been selected, play will begin. The selected track number blinks in the display as it is being played.

NOTE (For disc changers)

When all the tracks on a certain disc have been played using random play, the next disc on the changer will start playing using the same function.

- 2 To change the track being heard, press the ►►|| button. Another track will be selected and played.

NOTE

Random play is canceled when you eject the disc.

CD/External disc control features

Magazine Random Play *(Function of disc changers)*

Play the tracks on all the discs in the disc changer in random order.

- 1 Press the M.RDM button to switch magazine random play on and off.
 'M-Random/MRDM ON' is displayed when magazine random play is turned on.
 The disc and track numbers will change over and over in the display as the next track is being selected.
 When the disc/track has been selected, play will begin.
 The selected disc/ track number blinks in the display as it is being played.

NOTE

This function is not available with the following models:
 KDC-C200/C300/C400/C301/C401

- 2 To change the track being heard, press the ►► button.
 Another disc/track will be selected and played.

NOTE

- Magazine random play is canceled when you eject the disc.
- The time needed for random selection depends on the number of discs loaded in the disc magazine.

Text Scroll

This function permits the text to be scrolled and the entire text to be displayed. The scrolling method differs depending on the setting of scrolling in the menu.

To scroll automatically:

Press the DISP button to display the disc title or the track title.
 The display of the text will be scrolled repeatedly.

To scroll manually:

- 1 Press the DISP button to display the disc title or the track title.
- 2 Pressing the DISP button for at least one second results in one scrolling display of the titles.

NOTE

Please see the menu settings (page 31) about switching between manual scrolling and automatic scrolling.

Function of the KDC-X615/KDC-6015

Disc Name Preset Play (DNPP)

Function of remote with DNPP button

If you have preset the name of a disc that you want to listen to in the disc changer, you can look for it by name and start playing it.

- 1 Press the DNPP button on the remote.
 'DNPP' will appear in the display, and the disc name preset play mode is entered.
 The names of all the discs in the disc changer will appear successively in the display for five seconds each.
 Discs whose names have not been preset will appear as 'NO NAME' in the display.

NOTE

- This function can only be used in disc changers that were manufactured or sold as of 1997. Also note that some units cannot provide a display unless the disc name preset has been made by the unit that is playing.
- Discs in the disc changer that have never been played before will appear as 'NO ACCES' when the disc names are displayed. When you cannot identify a disc because of the 'NO ACCES' display after inserting a disc magazine, try playing it using the disc scan or a similar function to display the disc name. Also note that 'NO DISC' will be displayed when a disc has not been loaded.

Rapid display (forward / reverse):

Press the DISC+ or DISC- button.

Pressing the DISC+ button will rapidly display the preset names/disc titles in order.

Pressing the DISC- button will rapidly display the preset names/disc titles in reverse order.

2 When the name appears for the disc you want to play

Press the OK button.

The disc whose name is displayed will be recalled, and the disc name preset play (DNPP) mode will end.

To cancel DNPP mode:

Press the DNPP button.

The disc name preset play (DNPP) mode will be canceled.

CD/External disc control features

Presetting Disc Names (DNPS)

Store the names of discs to be displayed when played.

- 1 Play the disc whose name you want to preset.

NOTE

- This function is not available for disc changers that do not feature the Disc Name Preset function.
- This procedure is not to be used to store the disc and track titles for MDs that you record.
- The disc name preset function cannot be used when a disc title name or track title is displayed.

- 2 Press the NAME.S button for at least two seconds. "NAME SET" is displayed and the disc name preset mode is entered. The cursor blinks in the position where character input can be made.

- 3 Press either the ◀◀ or ▶▶ button to move the cursor to the desired position. The ◀◀ button moves the cursor to the left, and the ▶▶ button to the right. You can also move the cursor left or right by pressing the TRACK+ or TRACK- buttons, respectively, on the remote control.

- 4 Each time the ▶|| button is pressed, the characters to be entered change as listed below. Press the DISC+ or DISC- button to display the desired character. Characters that can be displayed are as follows.

Alphabet (upper case): A ~ Z

Alphabet (lower case): a ~ z (KDC-X615/6015 Only)

Numerals and symbols: 0~9 @ " ' ` % & * + - = , . / \ < > []

Special characters: á à é è í î ó ò ú û ñ ç \$ ß i j ä å ë

ë ì ï ô õ ù ü ñ ç \$ ÿ i j
(KDC-X615/6015 Only)

NOTE

The operation and characters that can be entered may change as listed below, depending on the unit that is connected. A press of the ▶|| button exits the disc name preset mode. Operations can be followed again from Step 2 at a time such as this, and the characters to be input are selected using the procedure described below. Press the DISC+ or DISC- button to display the desired character. Besides the alphabet (capital letters only) and numbers, you can choose the following characters: /, +, -, *, =, <, >, [and].

NOTE Direct Alphabet Input

(Function of remote with number/letter entry buttons)

If the disc changers that were manufactured and sold after 1997 (except for KDC-C560) are connected, you can directly input letters using the number/letter entry buttons on the remote. Example: Use the following table to enter the name "DANCE".

Character	Button to press	# Times pressed
"D"	#3	1
"A"	#2	1
"N"	#6	2
"C"	#2	3
"E"	#3	2

- 5 Continue steps 3 and 4 until all the characters are chosen for the name.
- 6 Press either the NAME.S button on the main unit or the OK button on the remote. The disc name is stored and the disc name preset mode is canceled. If you make no entry in a 10-second period, the name will be stored with the characters input so far.

NOTE

- The number of characters and discs whose names can be stored will differ depending on the disc changer that is

- connected. Please see your disc changer manual for details. Up to 8 characters and 30 CDs can be registered with this unit.
- Discs are identified by their total length and number of tracks. If another disc happens to have the same specifications as one that you have already stored a name for, the name will be displayed for it, too.
 - If you want to change the name of a disc, repeat steps 1 and 2 to display the name, and then repeat steps 3 and 4 to input the changes.
 - Pressing the reset button erases the disc names stored in this unit, but does not erase names stored in a disc changer.

Menu settings

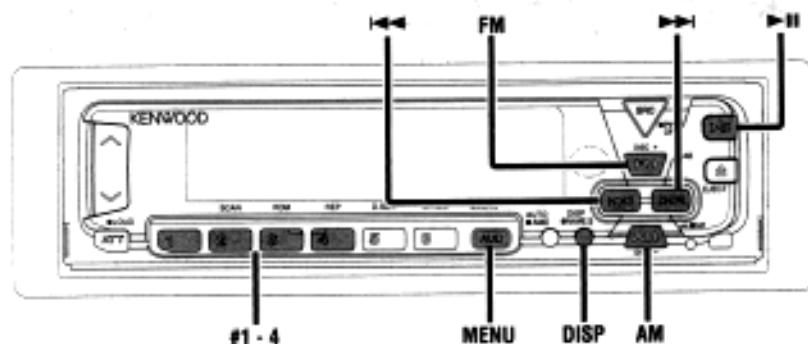

KDC-X615/KDC-6015

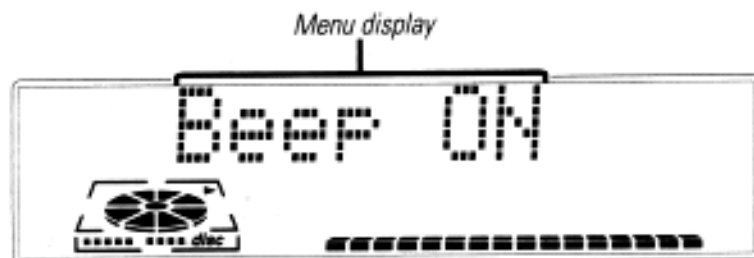

KDC-515S

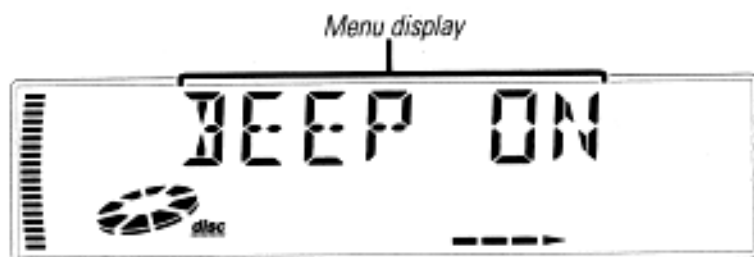

Menu settings

Menu System

You can set the defaults for additional functions in the menu mode.

Make a setting for each function, referring to the following operations.

1 Enter the menu mode

Press the MENU button for at least one second. "MENU" is displayed when the menu mode is entered. The function that you can adjust is indicated with the current settings displayed.

2 Selecting function to set

Press the FM button to search through the functions until you see the one you want to adjust in the display. Press the AM button to search through the functions backward.

Example: If you want to switch the setting of the touch sensor tone function from on to off, first search through the functions until you see "Beep/BEEP ON" in the display.

Beep ON BEEP ON

3 Changing setting for currently displayed function

Press either the ◀◀ or ▶▶ button.

The setting will change for each function.

Example: The setting of the touch sensor tone will switch from on to off, and "Beep/BEEP OFF" is displayed.

Beep OFF BEEP OFF

4 Ending the menu mode

Press the MENU button.

NOTE

Make sure to end the menu mode when finished.

Touch Sensor Tone

This function produces a beep sound that accompanies button operation. It can be switched on or off.

Display and setting:

"Beep/BEEP ON" : Beep setting is on.

"Beep/BEEP OFF" : Beep setting is off.

NOTE

The beep sound is not output from the preout jacks.

Manual Time Adjustment

Adjust the time manually.

Display and setting:

- 1 Select the display "Clock Adjust/CLK ADJ" during the selecting function in the menu system.
- 2 Press either the ◀◀ or ▶▶ button for at least two seconds to enter the Manual time adjustment mode. The time display will blink.
- 3
 - Adjusting the hours
Press the FM button to advance the hours, or press the AM button to make the hours go back.
 - Adjusting the minutes
Press the ▶▶ button to advance the minutes, or press the ◀◀ button to make the minutes go back.
- 4 Press the MENU button to end the menu mode.

Calendar Adjustment

Adjust the date for the unit so that you can use the calendar function.

Display and setting:

- 1 Select the display "Date Adjust/DATE ADJ" during the selecting function in the menu system.
- 2 Press either the **◀◀** or **▶▶** button for at least two seconds to enter the Calendar adjustment mode.
The date display will blink.
- 3 **Selecting the item (day, month, or year) to adjust**
Press the **◀◀** or **▶▶** button.
The item blinking in the display can be adjusted.
- 4 **Adjusting the date**
Press the FM or AM button.
The item of the date blinking in the display will change.
- 5 Press the MENU button to end the menu mode.

Calendar Mode

You can set the date formats of the calendar function.

Display and setting:

- 1 Select the display "Date Mode/DATE MOD" during the selecting function in the menu system.
- 2 Press the **◀◀** and **▶▶** button to select the date format you want to show in the display.
The sample of the date format for today is displayed.

Menu settings

Memo Mode

You can input the text to be displayed and set the date when that text will appear in the display with the calendar function.

Display and setting:

- 1 Select the display "Memo Mode/MEMO MOD" during the selecting function in the menu mode.
- 2 Press either the ◀◀ or ▶▶ button for at least two seconds to enter the Memo mode.
The date display will blink.
- 3 **Selecting the set of the date and text to be displayed**
Press the FM and AM button.
If you want to input a new text, select the blank display.
- 4 **Entering the month or day setting mode**
Press the ◀◀ and ▶▶ button to enter the month or day setting mode.
The month display blinks when in month mode, the day display blinks when in day setting mode.
- 5 **Changing the month or day**
Press the FM and AM button.
- 6 **Entering the text input mode**
Press the ▶▶ button to enter the text input mode.
The cursor blinks in the position where character input can be made.
- 7 **Inputting / Changing the text**
 - Moving the cursor
Press the ◀◀ and ▶▶ button.
 - Changing the type of characters
Press the ▶|| button.
Each time the button is pressed, the type of characters switches as follows.

Alphabet (upper case): A ~ Z

Alphabet (lower case): a ~ z (KDC-X615/6015 Only)

Numerals and symbols: 0~9 @ " ' ` % & * + - = , . / \ < > []

Special characters: á à é ê í î ó ò ú û ñ ç \$ β i j ä å è
ë ì ï ð ñ ò ó ô õ ñ ç \$ ÿ i j
(KDC-X615/6015 Only)

- Selecting the character
Press the FM and AM button.
- 8 Press the MENU button to end the menu mode.

NOTE

- The text you selected automatically appears on the date you set when the unit's power is first turned on. (Calendar function)
The DISP button for at least one second scrolls the display once, regardless of the text scroll setting.
Pressing a button other than the DISP button will cause the text to disappear from the display.
- You can enter up to 32 characters for each text.
- The calendar function can be set up to 30 cases.
- To delete the date and text setting, set both the month and day of the date to "00" or set all of the text to blanks.

Security Code

When the battery is removed from the unit's power switch, you cannot turn on the unit again unless the preset security code is input. This function helps prevent theft.

NOTE

You must follow steps 1 to 9 to be able to use the Security Code function. Turning off the power during the procedure will deactivate the security code setting.

Once the security code function has been activated, "Security/SECURITY" disappears from the MENU system. Note that it will no longer be possible to cancel this function afterwards.

- 1 Press the SRC button repeatedly to select the standby mode. "ALL OFF" is displayed when the standby mode is selected.
- 2 Select the four digits to use in your security code.

NOTE

The four-digit security code is very important, as you will need it to turn the unit on again when the code security function is on. Choose the number carefully and do not forget it (write it down and keep it separately in a safe place).

- 3 Press the MENU button for at least one second. "MENU" is displayed and the menu mode is turned on.
- 4 Keep pressing the FM button until the "Security/SECURITY" appears in the display. Press the AM button to search in the other direction.
- 5 Press either the ◀◀ or ▶▶ button for at least two seconds. "ENTER" will appear in the display for one second, indicating the code setting mode has been entered. When "CODE" appears in the display, you can start inputting the code.
- 6 Press the preset button and enter the security code that you have selected in step 2.
Example: Use "3510" as the security code.

Step	Button to press	# Times pressed	Display
1	#1	4	"3"
2	#2	6	"5"
3	#3	2	"1"
4	#4	1	"0"

- 7 Press the DISP button for at least three seconds. The security code will be set. "RE-ENTER" will appear in the display for one second, asking you to enter the code once again for confirmation. When

"CODE" appears in the display, you can start inputting the code.

- 8 Press the Preset button and input the security code again.
- 9 Press the DISP button again for at least three seconds. "APPROVED" will appear in the display, with the security code function turning on. From this point on, if the unit is disconnected from the battery, the security code must be entered the first time that the unit's power is turned on. "ENTER" and "CODE" will appear in the display, asking you to input the code.

NOTE

If you input an incorrect security code, the code setting mode will be canceled automatically. Follow the steps from 5 to 9 above again.

If you press the RESET button or remove the battery:

The first time you turn the unit on again, "CODE" will appear in the display, asking you to input the security code. Repeat steps 8 and 9 above, and input the security code. You can start operating the unit again when "APPROVED" appears in the display. If you enter the incorrect code, the power will turn off. Enter the correct code to turn the unit on.

Function of the KDC-X615/KDC-6015

Selectable Illumination

You can switch the color of the button illumination between green and red.

Display and setting:

"Color Green/COL GRN" : The color of the illumination is green.
"Color Red/COL RED" : The color of the illumination is red.

Menu settings

Function of the KDC-X615/KDC-6015

Contrast Adjustment

This adjustment permits easy viewing of the display.

Display and setting:

"Contrast 0" – "Contrast 10"

NOTE

The initial setting value is "5".

Function of the KDC-X615/KDC-6015

Dimmer

You can dim the display.

NOTE

The dimmer function is not available for units if the dimmer wire is not connected.

Display and setting:

"Dimmer ON" : The dimmer setting is on.

"Dimmer OFF" : The dimmer setting is off.

Switching Graphic Display

You can turn the movement of graphic display on and off. The initial setting is ON.

Display and setting:

"Graphic/GRAP ON" : The graphic display works.

"Graphic/GRAP OFF" : The graphic display does not work.

Black Mask

This function allows you to turn off the lower part of the display if there is too much information in the display.

Display and setting:

"BLK MASK/BMSK ON" : The display will turn on by using only the upper part of the display and the IN indicator (KDC-X615/6015 only).

"BLK MASK/BMSK OFF" : The display will turn on by using the whole part of the display.

Function of the KDC-X615

Switching preout

Switch the preout between the rear and non-fading. When you switch to non-fading, you can adjust the volume separately. The factory default is rear preout.

Display and setting:

"SWPRE Rear" : Rear preout

"SWPRE N-Fad" : Non-fading preout

NOTE

You cannot use the high-pass filter with non-fading preout.

KEX/ec4/dB (Sound Coordinate system)

When this system is set to on, the sound coordinate factors (Bass Frequency, Bass quality, Bass extension, and Treble frequency) appear during the audio control mode.

Display and setting:

"Kex/ec4/dB (set) ON" : The sound coordinate factors appear and can be adjusted.

"Kex/ec4/dB (set) OFF" : The sound coordinate factors are not appeared.

External Amp Control

Adjust the bass boost level of the external amplifier using the main unit.

Display and setting:

- *AMP BASS FLT* : Bass boost level is flat.
- *AMP BASS +6* : Bass boost level is low (+6dB).
- *AMP BASS +12* : Bass boost level is high (+12dB).

NOTE

As of December 1999, the power amplifiers controllable by the main unit are as follows:
KAC-X501F/PS501F/X401M/PS401M/X301T/PS301T/X201T/PS201T

Clean Reception System Circuit (CRSC)

Temporarily have reception switched from stereo to mono to reduce multi-path noise when listening to the FM station. The factory default for this function is ON.

Display and setting:

- *CRSC ON* : The CRSC is on.
- *CRSC OFF* : The CRSC is off.

NOTE

Strong electrical fields (such as from power lines) may cause unstable sound quality when CRSC is turned on. In such a situation, turn it off.

Text Scroll

This function permits the CD text, MD title, and Calender function to be scrolled and the entire text to be displayed. Switching between manual scrolling and automatic scrolling is permitted. The factory default is automatic scrolling.

Display and setting:

- *Scroll Auto/SCL AUTO* : Automatic scrolling

Basic Operations of remote

Optional for the KDC-515S

KDC-X615

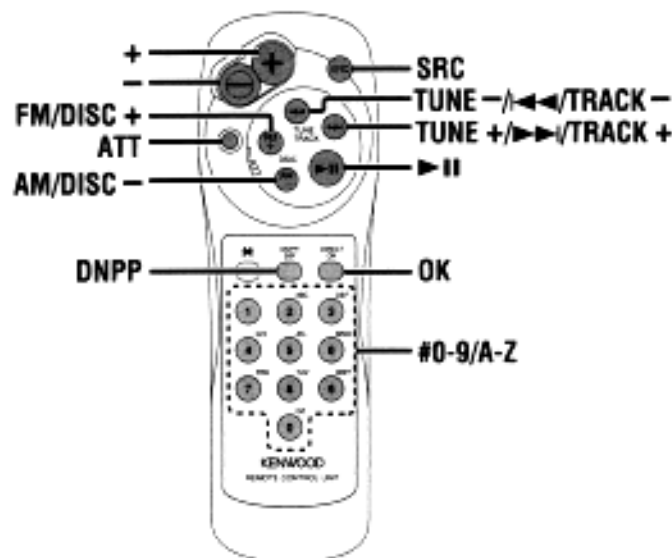

KDC-6015

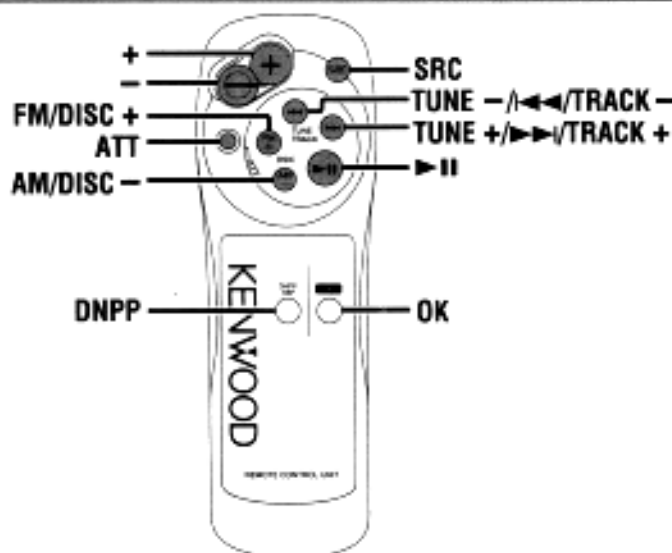

⚠ CAUTION

Do not set the remote on hot places such as above the dashboard.

Loading and Replacing the Batteries:

Use two "AAA"-size batteries.

Slide the cover while pressing downwards to remove it as illustrated.

Insert the batteries with the + and - poles aligned properly, following the illustration inside the case.

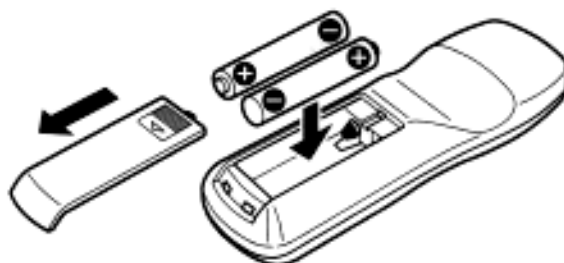

⚠ WARNING

Store unused batteries out of the reach of children. Contact a doctor immediately if the battery is accidentally swallowed.

NOTE

- The provided batteries are intended for use in operation checking, and their service life may be short.
- When the remote controllable distance becomes short, replace both of the batteries with new ones.

NOTE

A portion of the operations may not be possible, depending on the unit that is connected.

Basic operations

- VOLUME buttons

Press the + button to turn the volume up.
Press the - button to turn the volume down.

- **SRC button**
Each time you press the SRC button, the mode switches as follows:

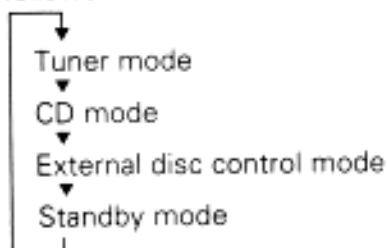

NOTE

- The mode switches to the next mode from any mode which cannot be used.
- The external disc control mode will differ depending on the unit that is connected.
- **ATT button**
Turns down the volume quickly. To return the volume to its original level, press the button again. Turning the volume up, or turning it all the way down deactivates the attenuator function.

Tuner features

- **◀◀/▶▶ (TUNE) buttons**
Press the ◀◀ button to make decreasing seeks (using the preset tuning mode).
Press the ▶▶ button to make increasing seeks (using the preset tuning mode).
Use to move the cursor left or right during station name input.
- **AM/FM button**
Press the AM button to select the AM band.
Press the FM button to select and switch between FM1, FM2, and FM3 bands.
During station name input, selects digits and symbols.

- **OK button**
During station name input, stores the already input data in memory and ends the input mode.
During Station name preset play mode, selects station.
- **DNPP button**
Enters and cancels the Station Name Preset Play mode.
- **▶|| button**
Enters and cancels the Program Type Selection (PTY) mode.
Selects the type of characters at the time of entering the station name.
- **Number/ letter entry buttons (KDC-X615 only)**
Press buttons #1-6 to recall preset stations.
Use to enter letters (alphabetical) during station name preset.







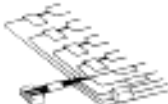

Basic Operations of remote

Optional for the KDC-515S

CD/External disc control features

- **◀◀/▶▶ buttons**
Press the ◀◀ button to search through the tracks backward.
Press the ▶▶ button to search through the tracks forward.
Use to move the cursor while entering disc name.
- **DISC buttons (for disc changers)**
Press the DISC- button to search through the discs backward.
Press the DISC+ button to search through the discs forward.
Select numbers and symbols while entering disc name.
- **▶|| button**
When a disc is playing, this button pauses the play.
Press the same button again to start play again.
Selects the type of characters at the time of entering the disc name.
- **OK button**
During disc name input, stores the already input data in memory and ends the input mode.
Selects disc during the disc name preset play mode.
- **DNPP button (for disc changers)**
Enters and cancels the Disc Name Preset Play mode.
- **Number/ letter entry buttons (KDC-X615 only)**
Used to specify the track (disc) number used in direct track (disc) searches.
Use to enter letters during disc name preset.

Accessories

	External view	Number of items
①	1
②	1
③	2
④	4
⑤	4
⑥	1
⑦	1
⑧	1

CAUTION

The use of any accessories except for those provided might result in damage to the unit. Make sure only to use the accessories shipped with the unit, as shown above.

Installation Procedure

1. To prevent a short circuit, remove the key from the ignition and disconnect the \ominus battery.
2. Make the proper input and output wire connections for each unit.
3. Connect the speaker wires of the wiring harness.
4. Connect the wiring harness wires in the following order: ground, battery, ignition.
5. Connect the wiring harness connector to the unit.
6. Install the unit in your car.
7. Reconnect the \ominus battery.
8. Press the reset button.

CAUTION

- If your car's ignition does not have an ACC position, connect the ignition wires to a power source that can be turned on and off with the ignition key. If you connect the ignition wire to a power source with a constant voltage supply, as with battery wires, the battery may die.
- If the console has a lid, make sure to install the unit so that the faceplate will not hit the lid when closing and opening.
- If the fuse blows, first make sure the wires aren't touching to cause a short circuit, then replace the old fuse with one with the same rating.
- Do not let unconnected wires or terminals touch metal on the car or anything else conducting electricity. To prevent a short circuit, do not remove the caps on the ends of the unconnected wires or the terminals.
- Connect the speaker wires correctly to the terminals to which they correspond. The unit may be damaged or fail to work if you share the \ominus wires or ground them to any metal part in the car.
- After the unit is installed, check whether the brake lamps, blinkers, wipers, etc. on the car are working properly.
- Insulate unconnected wires with vinyl tape or other similar material.
- Some disc changers need conversion cords for connection. See the section on "Safety Precautions" for details.
- Mount the unit so that the mounting angle is 30° or less.

Connecting Wires to Terminals

▲WARNING

If you connect the ignition wire (red) and the battery wire (yellow) to the car chassis (ground), you may cause a short circuit, that in turn may start a fire. Always connect those wires to the power source running through the fuse box.

▲CAUTION

When only two speakers are being connected to the system, connect the connectors either to both the front output terminals or to both the rear output terminals (do not mix front and rear). For example, if you connect the + connector of the left speaker to a front output terminal, do not connect the - connector to a rear output terminal.

NOTE

To connect the Disc changer or DAB unit, consult each manual.

KENWOOD disc changer / DAB control input / Display Data Output Jack
Outputs data representing the unit's current state, causing it to appear in the external display. To connect to this jack, a converting adapter (optional) is necessary. (KDC-X615/6015 only)

FM/AM antenna input

Wiring harness (Accessory ①)

If no connections are made, do not let the wire come out from the tab.

When using the optional power amplifier, connect to its power control terminal.

Connect either to the power control terminal when using the optional power amplifier, or to the antenna control terminal in the vehicle.

To car light control switch

To "EXT.AMP.CONT." terminal of the amplifier having the external amp control function.

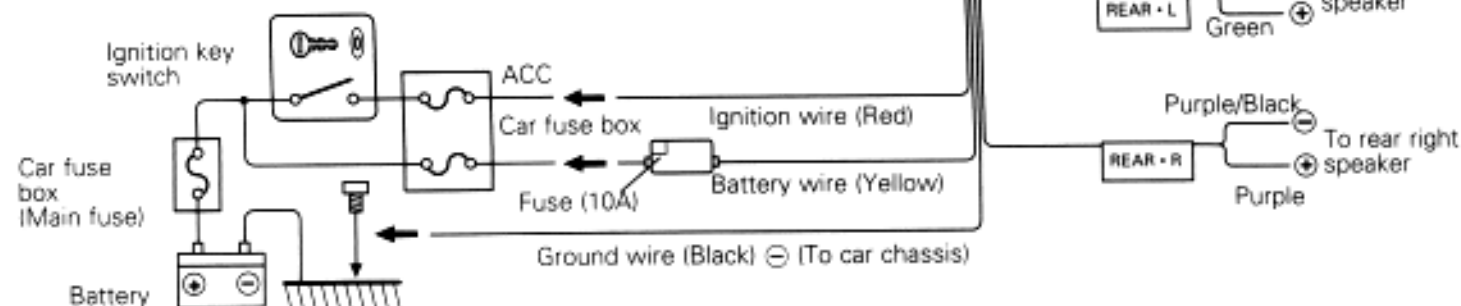

■ Installation

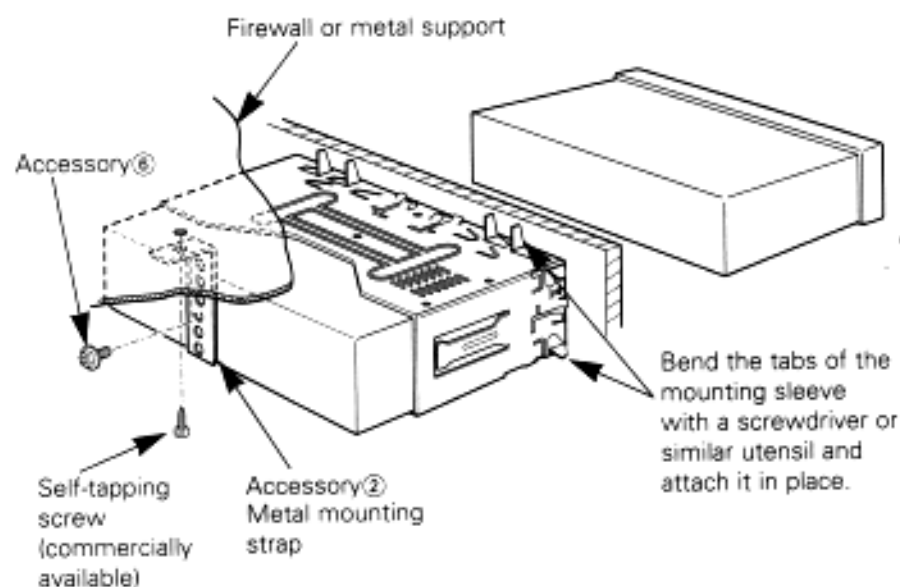

NOTE

Make sure that the unit is installed securely in place. If the unit is unstable, it may malfunction (for example, the sound may skip).

■ Installing in Japanese-Made Cars

- 1 Refer to the section "Removing the hard rubber frame (P. 38)" and then remove the hard rubber frame.
- 2 Mount the J-Car trim plate with the thick part at the bottom.
- 3 Align the holes in the unit (two locations on each side) with the vehicle mounting bracket and secure the unit with the accessory screws.

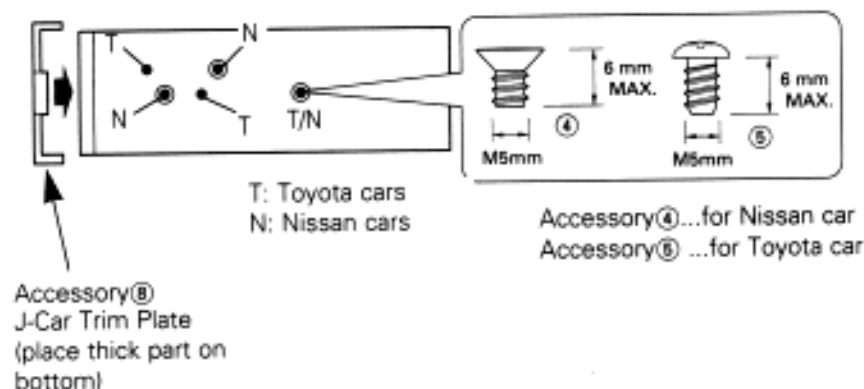

CAUTION

- During installation, do not use any screws except for those provided. The use of different screws might result in damage to the main unit.
- Damage may occur if a screwdriver or similar tool is used with excessive force during the installations.

■ **Removing the hard rubber frame**

- 1 Refer to the section "Theft deterrent faceplate (P. 12)" and then remove the faceplate.
- 2 Engage the catch pins on the removal tool and remove the two locks on the upper level.
Push upward the frame and pull it forward as shown in the figure.

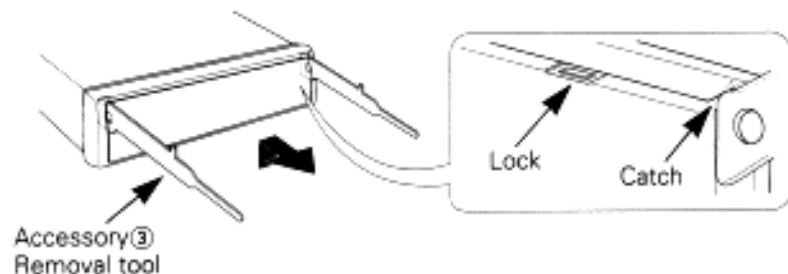

- 3 When the upper level is removed, remove the lower two locations.

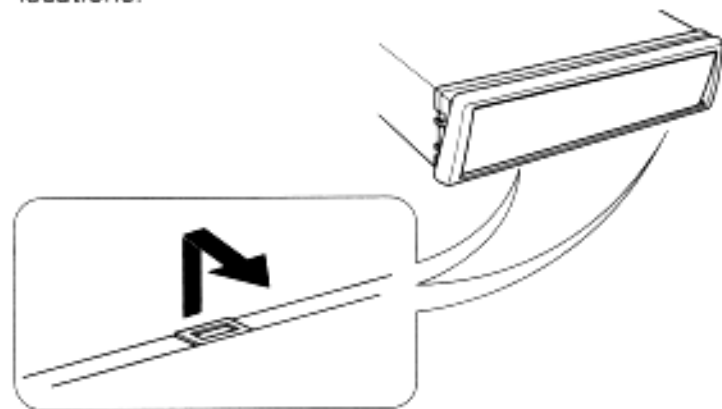

NOTE

The frame can be removed from the bottom side in the same manner.

■ **Removing the Unit**

- 1 Refer to the section "Removing the hard rubber frame (P. 38)" and then remove the hard rubber frame.
- 2 Remove the Hex-head screw with integral washer (M4x8) on the back panel.
- 3 Insert the two removal tools deeply into the slots on each side, as shown.

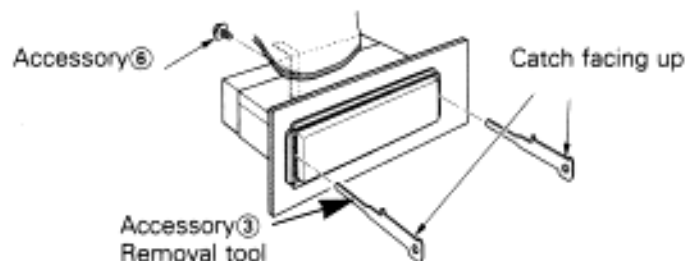

- 4 Push upward the removal tool toward the top, and pull out the unit halfway whilst pressing towards the inside.

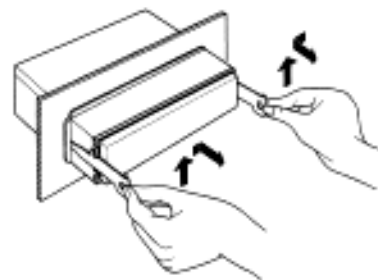

CAUTION

- Be careful to avoid injury from the catch pins on the removal tool.

- 5 Pull the unit all the way out with your hands, being careful not to drop it.

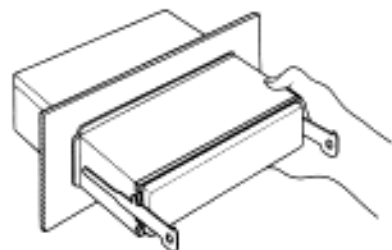

Installation

■ Locking the faceplate to the unit

If you want to lock the faceplate to the unit so that it does not fall off, follow the directions below.

- 1 Refer to the function "Theft Deterrent Faceplate" (page 12) and remove the faceplate.

- 2 Insert the provided screw into the hole at the center of the bottom side of the faceplate which you have removed from the unit.

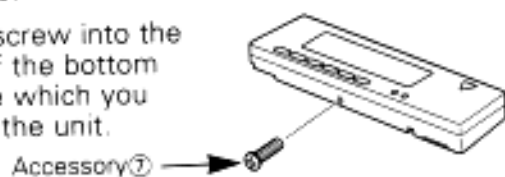

- 3 Push back the bottom of the faceplate bracket until it locks.
- 4 Refer to the section "Theft Deterrent Faceplate (page 12)" and then reattaching the faceplate.

CAUTION

Never insert the tapite screws ($\phi 2 \times 6$ mm) in any other screw holes than the one specified. If you insert it in another hole, it will contract and may cause damage to the mechanical parts inside the unit.

Troubleshooting Guide

What might seem to be a malfunction in your unit may just be the result of slight misoperation or miswiring. Before calling service, first check the following table for possible problems.

PROBLEM	POSSIBLE CAUSE	SOLUTION
The power does not turn on.	The fuse has blown.	After checking for short circuits in the wires, replace the fuse with one with the same rating.
No sound can be heard, or the volume is low.	Attenuator is turned on.	Turn off Attenuator.
	The fader or balance settings are set all the way to one side.	Reset the fader or balance settings.
	The input/output wires or wiring harness are connected incorrectly.	Reconnect the input/output wires or the wiring harness correctly. See the section on "Connecting Wires to Terminals".
Nothing happens when the buttons are pressed.	The computer chip in the unit is not functioning normally.	Press the reset button on the unit (see p. 5).
The sound quality is poor or distorted.	One of the speaker wires is being pinched by a screw in the car.	Check the speaker wiring.
	The speakers are not wired correctly.	Reconnect the speaker wires so that each output terminal is connected to a different speaker.
Radio reception is poor.	The car antenna is not extended.	Pull the antenna out all the way.
	The antenna control wire is not connected.	Connect the wire correctly, referring to the section on "Connecting Wires to Terminals".
The memory is erased when the ignition is turned off.	The battery wire has not been connected to the proper terminal.	Connect the wire correctly, referring to the section on "Connecting Wires to Terminals".
	The ignition and battery wire are incorrectly connected.	Connect the wire correctly, referring to the section on "Connecting Wires to Terminals".
A CD ejects as soon as it is loaded.	The CD is upside-down.	Load the CD with the labeled side up.
	The CD is quite dirty.	Clean the CD, referring to the section on "Cleaning CDs" (see p. 6).
The sound skips on a CD.	The CD is scratched or dirty.	Clean the CD, referring to the section on "Cleaning CDs" (see p. 6).
A track will not play.	Random play has been selected.	Turn off random play.

CD/MD/External disc control mode

PROBLEM	POSSIBLE CAUSE	SOLUTION
The disc control mode cannot be selected.	No wire has been connected to the disc changer input terminal on the unit.	Connect the wire to the disc changer input terminal on the unit.
The specified disc does not play, but another one plays instead.	The specified CD is quite dirty.	Clean the CD.
	The CD is upside-down.	Load the CD with the labeled side up.
	The disc is loaded in a different slot from that specified.	Eject the disc magazine and check the number for the specified disc.
	The disc is severely scratched.	Try another disc instead.
The sound skips.	Something is touching the disc changer.	Remove whatever is touching it.
	The CD is scratched or dirty.	If skipping happens at the same place when the car is stopped, something with the CD is wrong. Clean the CD.
The display shows that the changer is being played, but no sound can be heard.	The computer chip in the unit is not functioning normally.	Press the reset button on the unit (see p.5).
The specified track will not play.	Random play or magazine random play has been selected.	Turn off random play or magazine random play.
Track repeat, disc repeat, track scan, disc scan, random play, and magazine random play start by themselves.	The setting is not cancelled.	The settings for these functions remain on until the setting is turned off or the disc is ejected, even if the power is turned off or the source is changed.

If the following situations, consult your nearest service center:

- Even though the disc changer is connected, the Disc Changer Mode is not on, with "AUX" showing in the display during the Changer Mode.
- Even though no device (KCA-S210A, CA-C1AX, KDC-CPS85, KDC-CX85, KDC-CPS82 or KDC-CX82) is connected, the AUX Mode is entered when switching modes.

Troubleshooting Guide

The following messages are displayed when certain problems are occurring in your system. Take the recommended actions.

- | | |
|----------|---|
| EJECT | No disc magazine has been loaded in the changer. The disc magazine is not completely loaded.
⇒ Load the disc magazine properly.
No CD in the unit.
⇒ Insert the CD. |
| NO DISC | No disc has been loaded in the disc magazine.
⇒ Load a disc into the disc magazine. |
| E-04 | No disc has been loaded in the disc magazine.
⇒ Load a disc into the disc magazine.
The CD is quite dirty. The CD is upside-down. The CD is scratched a lot.
⇒ Clean the CD and load it correctly. |
| BLANK | Nothing has been recorded on the MD. |
| NO TRACK | No tracks are recorded on the MD, although it has a title. |
| NO PANEL | The faceplate of the slave unit being connected to this unit has been removed.
⇒ Replace it. |
| E-77 | The unit is malfunctioning for some reason.
⇒ Press the reset button on the unit. If the "E- 77" code does not disappear, consult your nearest service center. |
| E-99 | Something is wrong with the disc magazine. Or the unit is malfunctioning for some reason.
⇒ Check the disc magazine. And then press the reset button on the unit. If the "E- 99" code does not disappear, consult your nearest service center. |
| HOLD | The protective circuit in the unit activates when the temperature inside the automatic disc changer exceeds 60°C (140°F), stopping all operation.
⇒ Cool down the unit by opening the windows or turning on the air conditioner. As the temperature falls below 60°C (140°F), the disc will start playing again. |
| IN | If this indicator blinks, the CD player is malfunctioning.
⇒ Eject the CD and try inserting it again.
If the CD cannot be ejected, press the eject button and hold it in until the CD is ejected. |

Specifications

Specifications subject to change without notice.

FM tuner section

Frequency Range (200 kHz Space)	87.9MHz-107.9MHz
Usable Sensitivity (S/N: 30dB)	9.3dBf (0.8 μ V/75 Ω)
Quieting Sensitivity (S/N: 50dB)	15.2dBf (1.6 μ V/75 Ω)
Frequency Response (\pm 3.0dB)	30Hz - 15kHz
Signal to Noise ratio	70dB(MONO)
Selectivity	\geq 80 dB(\pm 400 kHz)
Stereo Separation	40dB(1kHz)

AM tuner section

Frequency Range (10 kHz space)	530kHz - 1700kHz
Usable Sensitivity (S/N: 20dB)	28 dB μ (25 μ V)

CD player section

Laser diode	GaAlAs (λ =780 nm)
Digital filter (D/A)	8 Times OverSampling
D/A Converter	1 Bit
Spindle speed	500 - 200 rpm (CLV)
Wow & Flutter	Below Mesurable Limit
Frequency response	10Hz - 20kHz (\pm 1 dB)
Total harmonic distortion	0.01%(1kHz)
Signal to Noise ratio	93dB(1kHz)
Dynamic range	93dB
Channel separation	85dB

Audio section

Maximum output power	45wx4
Full Bandwidth Power (at less than 1% THD)	22wx4
Tone action	
Bass	100Hz \pm 10dB
Treble	10kHz \pm 10dB
Preout Level(mV)/Load (during CD play)	1800mV/10k Ω
Preout Impedance	\leq 600 Ω

General

Operating voltage (11 - 16V allowable)	14.4 V
Current Consumption	10A
Installation Size (W x H x D)	182 x 53 x 161 (mm) 7-3/16 x 2-1/16 x 6-5/16
Weight	4.0 lbs(1.8kg)